

LENS AND MODE COMBINATIONS

ISO	Shutter speed
25/15°	4 to 1/1000 sec.
50/18°	2 to 1/1000 sec.
100/21°	1 to 1/1000 sec.
200/24°	1/2 to 1/1000 sec.
400/27°	1/4 to 1/1000 sec.

The accurate working range of shutter speeds of the X-700 depends on the film speed, as shown in the table. If you release the shutter when the LEDs indicate a speed outside the applicable range, exposure may be incorrect.

The table at right shows the usable modes for various types of lenses and accessories. Because the X-700 meters while the diaphragm is closing to obtain correct exposure in auto modes, operation may be somewhat different than stated in the lens or accessory manual. Special instructions for specific lenses and accessories are as follows:

- Only MD lenses should be used in P mode. If a non-MD lens is used, the "P" will blink as a warning that exposure may be incorrect.
- When using an Auto Rokkor lens, Auto Bellows I, or Auto Bellows III with the X-700, you need to press the preview button only when you want to check the shutter speed that will be used in A mode or the recommended shutter speed in M mode, not when you actually release the shutter. For Auto Bellows III, press the preview button on the bellows itself.

Lens or accessory	Mode
MD	P A M
MD plus MD 2X Tele Converter	P A M
MC	— A M
Auto Rokkor	— A M
Manual preset	— A M
RF (mirror)	(P) A M
CA Shift	— — M
Varisoft	— A M
MD or MC plus: MC 2X Tele Converter Close-up accessories	— A M

- Though RF lenses (which have a fixed aperture) can be used with the mode selector at "P", they will function in the same way as when it is at "A".

APERTURE-PRIORITY AUTO-EXPOSURE MODE (A mode)

Basic settings

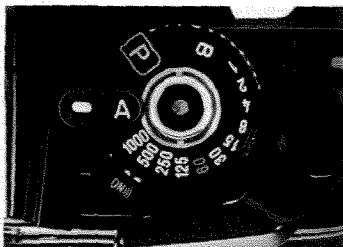

Set mode selector at "A".



Set lens at desired aperture.

Taking pictures in A mode

After you have set the mode selector and desired aperture as shown at left, the camera will automatically select the stepless shutter speed needed for proper exposure. All you need do before releasing the shutter is compose, focus, and check the viewfinder as follows:

- Is the over-range LED blinking? If so, turn the aperture ring towards $f/22$ until the LED stops blinking. If it does not stop, use a neutral-density (ND) filter or reduce the light level if possible.
- Is an LED on in the danger zone for hand-holding (usually $1/30$ sec. or slower — see p. 44)? Or does the slow-shutter-speed warning beep when the main switch is at "ON" and you touch the operating button? If so, turn the aperture ring towards $f/1.7$ until an LED outside the danger zone lights. If impossible, use a suitable

camera-support method (p. 46) or a flash (p. 50).

- Is an LED on or blinking outside the applicable range from the table on page 31? If so, exposure may be incorrect.

NOTES

- In some situations you may want to use the AE lock or exposure-adjustment control (pp. 34 and 35).
- If your head is not shielding the eyepiece from light when the picture is taken, use the eyepiece cap (p. 25).
- Almost all Minolta lenses and close-up accessories can be used in aperture-priority AE mode. See page 31 for special instructions for some of them.

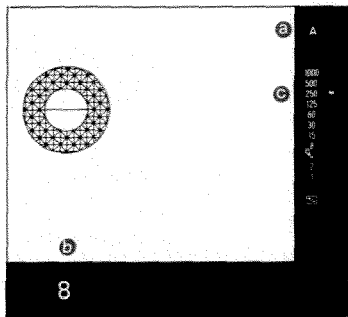

Viewfinder shows:

- Ⓐ Red "A" = Aperture-priority AE mode in use
- Ⓑ Aperture you selected (equals taking aperture)
- Ⓒ Stepless shutter speed set by camera for that aperture (If two LEDs light, speed is in between.)

Selecting an aperture

In aperture-priority AE mode, your X-700 will set the precise shutter speed for proper exposure automatically. Even so, you have considerable control over results and can adjust aperture and shutter speed over considerable ranges to suit the conditions and yourself.

For good pictures with a minimum of care where no particular effect is desired, simply set the aperture as indicated in the table. These guide settings will provide as much depth of field (see p. 42) as possible while producing a shutter speed fast enough to stop the motion of most subjects and guard against blur from camera movement (see p. 44).

ISO	Sunny	Hazy Sun	Heavy Over-cast	Indoors
25/15°	f/8	f/4	f/2	f/1.4
64/19°	f/8	f/4	f/2.8	f/1.4
100/21°	f/11	f/5.6	f/4	f/1.4
160/23°	f/11	f/8	f/5.6	f/2
200/24°	f/11	f/8	f/5.6	f/2
400/27°	f/16	f/11	f/8	f/2.8

(These are only guidelines for typical picture-taking situations. For additional information see p. 48).

Your X-700's center-weighted averaging meter system is designed so that light from all parts of the viewfield (picture area) is measured by the silicon photocell but influence from a broad central area is greatest. Thus the reading should give satisfactory exposure without adjustment as long as the main subject area occupies a major part of the center of the frame. When it does not, you may want to use the AE lock to take a close-up reading or the exposure-adjustment control to increase or decrease exposure by up to two stops (see the two sections at right and box on pages 36 and 37).

As with most metering systems, strong sources of direct light or other very bright areas may adversely influence the reading if allowed to dominate the frame.

Though the X-700's viewfinder is designed to minimize the effect on the meter of light entering through the eyepiece under usual conditions, you should be careful to shield the eyepiece — especially if you wear glasses — in the following situations:

- When the subject is in shade and the camera is in sunlight
- When bright sidelight falls between eye and eyepiece
- When stop-down metering is used (p. 31)

To shield the eyepiece, use a rubber eyecup or place your thumb so that it blocks sidelight. When viewing is unnecessary, the eyepiece cap (p. 25) can be used to completely eliminate the problem.



To obtain proper exposure in high-contrast lighting situations where your subject is on the edge of the frame or occupies only a small portion in the center, use the AE lock as follows:

1. Shift the camera's position so the subject fills most of the frame. For small subjects, you may need to move closer.
2. With the viewfinder LED display on, press the AE lock all the way down and hold it there; you may

then remove your finger from the operating button if desired.

3. Recompose your picture as desired.

4. Release the shutter while still holding the AE lock down.

NOTES

- Suggestions on when to use the AE lock are given on pages 36 and 37.
- The AE lock cannot be used in M mode or together with the self-timer.
- If you wish to change the settings of film speed, exposure adjustment, mode/shutter-speed, or aperture, do so before pressing the AE lock.
- The AE lock does not operate if pressed while the motor drive is used at "Hi".

EXPOSURE-ADJUSTMENT CONTROL

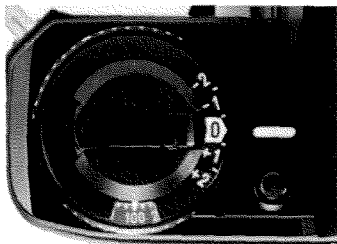

To deliberately increase or decrease exposure from the normal metered value, turn the exposure-adjustment control while pressing the lock release until the desired position is aligned with the index. Set minus (-) numbers to darken exposure and plus (+) numbers to lighten exposure, as indicated in the table.

NOTES

- The control will lock at "0" and each half-stop setting, though settings between half stops can also be used.

-2	two stops less = one-quarter normal exposure
-1	one stop less = one-half normal exposure
0	normal exposure
+1	one stop more = double normal exposure
+2	two stops more = four times normal exposure

- When the control is not at "0", the +/- LED in the viewfinder will blink to let you know exposure is being adjusted.
- Be sure to return the control to "0" after using exposure-adjustment settings.
- Both aperture and shutter speed are changed by exposure adjustment in P mode; in A mode, only shutter speed is adjusted.

WHEN TO USE AE LOCK AND EXPOSURE-ADJUSTMENT CONTROL

The following suggestions on when to use the AE lock or exposure-adjustment control can serve as starting points for trial; individual conditions and taste will, of course, determine what exposure you choose.

- In situations where there is a great brightness difference between the subject and background and the most important area is considerably darker than the area surrounding it, use the AE lock to lock the meter reading with the camera positioned so the subject fills most of the finder, or set the exposure-adjustment control at $+1/2$ to $+2$ stops. Examples are pictures with strong backlighting and no fill-in illumination (such as photos A and B), or subjects against a background of snow or light-colored sand, unless the bright area occupies a very small part of the frame.
- If the most important subject area is much brighter than the rest of the picture, use the AE lock as above or set the exposure-adjustment control at $-1/2$ to -2 stops. Examples are subjects in a spotlight or shaft of sunlight or against a very dark background (such as photos C and D), unless the background occupies only a small area in the frame.
- When copying documents printed on white stock or on other predominantly light-colored materials, an adjustment of $+1/2$ to $+2$ stops may be necessary. Similarly, you will probably want to make an adjustment of $-1/2$ to -2 stops for predominantly dark copy material, or that on a dark background.
- When using an R60 (red) filter, adjust exposure $+1$ stop.

A. Without AE lock or adjustment



C. Without AE lock or adjustment



B. Exposure increased

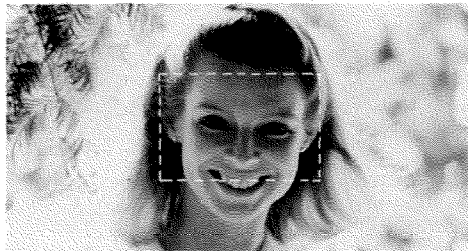

D. Exposure decreased

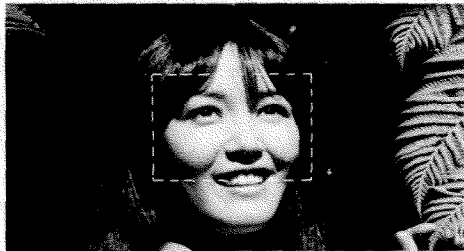

The same results can be obtained by using the AE lock while framing the face within the rectangle, then recomposing before releasing the shutter.

METERED/FULL-MANUAL EXPOSURE MODE (M mode)

Basic setting

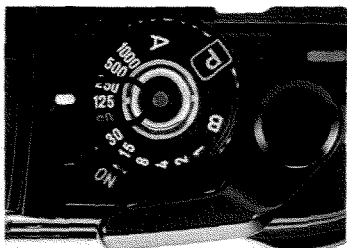

Set mode/shutter-speed selector at any position from "1" to "1000".

Taking a picture in M mode

To use the X-700 in metered- or full-manual mode, first release the mode/shutter-speed selector from "P" or "A" and check to see that the lens is not locked at minimum aperture.

There are two ways to use metered-manual mode:

- When you wish to use a certain shutter speed, first set the selector at any click-stop setting from 1 sec. to 1/1000 sec., then turn the aperture ring until the LED next to that speed lights up.
- When you wish to use a certain aperture, first set the aperture ring, then set the stepped shutter speed according to the value recommended by the LED. If two LEDs light up, adjust the aperture ring somewhat until only one lights. Do not set the shutter-speed selector between click stops.

Number agreement can, of course, be disregarded and any shutter-speed and lens-aperture combination set for full manual operation (see p. 29).

NOTE

- In M mode, the slow-shutter-speed warning indicates that the camera-recommended setting — NOT the actual setting — is 1/30 sec. or slower.

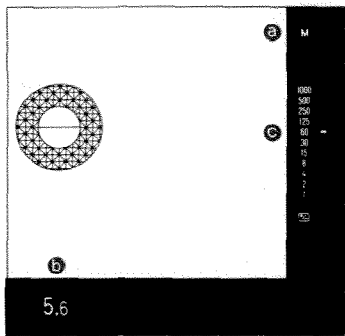

Viewfinder shows:

- Red "M" = Manual mode in use
- Aperture you selected (equals taking aperture)
- Shutter speed recommended by camera for that aperture
NOT ACTUAL SPEED SET

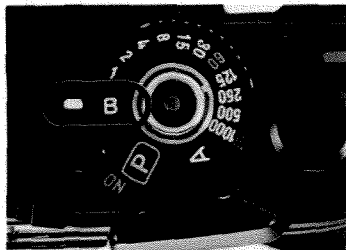

Long exposures ("B" setting)

When the mode/shutter-speed selector is set at "B", the shutter will open when you press the operating button and remain open until you release it, making exposures longer than one second possible. A tripod (p. 46) or other firm support should generally be used. To avoid jarring the camera when pressing or releasing the operating button, use a standard cable release (preferably a lockable type for longer expo-

sure) or a Minolta electronic remote cord (p. 47). The eyepiece cap (p. 25) should be used to prevent stray light from affecting the exposure.

NOTES

- The self-timer does not operate at the "B" setting.
- With fresh batteries at moderate temperatures, the maximum long exposure is approx. 3 hours. At lower temperatures, exposure time may be shorter. Exposures up to 6 hours long are possible by using a fresh lithium battery.
- For automatically timed long exposures, use the accessory Multi-Function Back (p. 55).

FOCUSING

Focusing aid

The X-700's standard focusing screen has a split-image spot surrounded by a band of microprisms in the center of an Acute Matte field.

To focus the camera visually with usual lenses, look through the viewfinder and turn the focusing ring of the lens until:

- Upper and lower subject images in the spot are exactly aligned with no broken lines between them,
- Subject image in the band does not shimmer or appear broken up, and
- Subject image within the focusing aid appears clearest and seems to blend with that on the matte field surrounding it.

Though the most satisfactory focusing aid and method depend upon the conditions and your personal preference, the above method may provide the best results with medi-

um wideangle to medium telephoto lenses.

Generally speaking, however, you will probably find that focusing is easiest if:

- Split-image spot is used for subjects having vertical lines.
- Microprism band is used for lenses from medium wideangle through medium telephoto, especially with subjects not having vertical lines.
- Matte field is used for longer-focal-length lenses or for macro or other work involving considerable lens extension.

NOTE

- The X-700's standard focusing screen can be replaced at any authorized Minolta service facility by any of eight optional focusing screens (see p. 57).



In focus



Out of focus

DEPTH OF FIELD

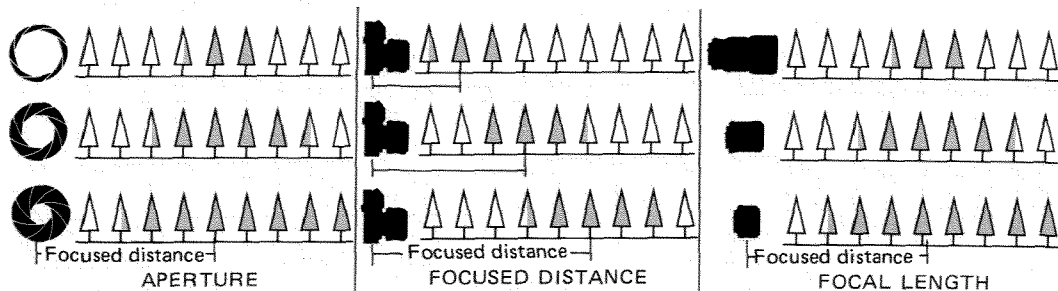

The range behind and in front of the focused distance within which the image appears acceptably sharp is called the depth of field.

It extends a greater distance behind the focused distance (usually about 1/3 in front, 2/3 behind) and is determined by three factors: the aperture, the distance at which the lens is focused, and the focal length of the lens. As illustrated by shaded trees above, depth of field increases as the lens is stopped down (e.g., $f/1.7$ to $f/22$) and becomes greater the farther from the camera the lens is

focused. It decreases as the lens is opened up (e.g., $f/22$ to $f/1.7$) and the closer the lens is focused. Depth of field is greater for short-focal-length lenses than for telephotos at the same focused distance and aperture. It is at its least for any given lens in normal mounting when the lens is at maximum aperture (as when metering and focusing normally with Minolta MD or MC lenses) and at minimum focusing distance.



Preview button

In A and M mode, depth of field at any focused distance and aperture can be checked visually by pushing the preview button all the way in. This will stop the diaphragm down to the aperture corresponding to the f-number set on the aperture ring, allowing you to see through the viewfinder how much of the subject is acceptably sharp.

NOTE

- The shutter speed indicated by LED while the preview button is pressed is NOT the actual shutter speed.



Depth-of-field scale

When the lens is focused at a given point, the image will be in satisfactory focus from the nearer value to the farther value on the distance scale indicated by the depth-of-field marks for the aperture in use. For example, if a 50mm f/1.7 lens is focused at 3m (about 10 ft.) and the aperture is f/8, the corresponding graduations to left and right of the index indicate acceptable sharpness from about 2.4 to 4.2m (approx. 8 to 14 ft.).

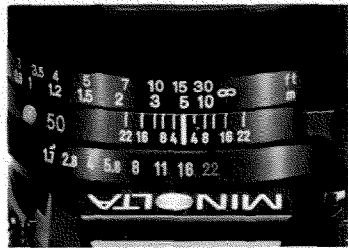

The depth-of-field scale can also be used to zone focus, i.e., set the focusing ring so that some anticipated action will take place within the limits of the depth of field. For example, if you want any subject within a range of 2.6m (approx. 8-1/2 ft.) to infinity to be reasonably sharp and the lighting conditions allow you to set an aperture of f/16 in A or M mode with a 50mm f/1.7 lens, set the lens so the infinity mark is opposite the "16" on the right end of the scale.

BLUR FROM CAMERA/SUBJECT MOVEMENT

A blurred photograph results when movement of the subject or camera during exposure causes a *shift in the position of the image on film*.

The shutter speed required to "freeze" an object's action normally increases as the object's speed increases; however, no matter what the speed, an object moving across the viewfinder field requires a faster shutter speed than one moving at the same speed directly toward or away from the camera. Similarly, a moving object near the camera (or one appearing nearer due to use of a longer-focal-length lens or a close-up accessory) requires a faster shutter speed than one farther away.

Blur from camera motion depends on such factors as the lens being used, the apparent closeness of the subject when viewed through the lens, the shutter speed, and the camera-support method. Since longer-focal-length lenses and close-up accessories increase the relative size of the subject, even a slight movement of the camera will be magnified on film; the greater weight and size of such lenses and accessories may also make it difficult to hold them steady. A good rule to

follow is that the slowest shutter speed that can be safely used by most people when hand-holding a lens is the *reciprocal of the focal length*. For example, for a 125mm lens, the speed would be 1/125 sec.; for a 300mm lens, it would be 1/500 (1/300 raised to the next faster speed to be on the safe side).

Use of a sufficiently fast shutter speed is also important when taking pictures from a moving, vibrating vehicle such as a boat, car, train, or plane (especially to prevent blurring the foreground, if any) or from a vibrating object such as a bridge. To reduce transmission of the vibrations through your body to the camera, relax your body and avoid direct contact with the object as far as possible.

SUPPORTING THE CAMERA AND RELEASING THE SHUTTER

In order to obtain sharp, blur-free photos, it is important to release the shutter gently while keeping the camera as still as possible. Always, regardless of shutter speed, release the shutter with a slow, steady squeeze — never a quick jab — preferably while holding your breath.

Shown at right are some ways of holding the camera to provide adequate support at normal and fast shutter speeds. If you grasp the camera firmly with your right hand on its front and back grips, you can easily shift it back and forth for horizontal (a) and vertical (b) pictures without removing your hand from its controls. Also, by cradling the camera in your left hand to support it, you can readily focus and set the aperture, if necessary, then shoot; another way is to use



your left hand to focus, then grasp the left part of the body for support. Photo (c) shows an alternative for holding the camera vertically. You should, of course, experiment to find the way that suits you best.



Slow-shutter-speed warning

When the main switch is set at "ON »" and the operating button is touched or slightly pressed, a slow-shutter-speed warning will beep if the camera sets (in P or A mode) or recommends (in M mode) a shutter speed of 1/30 second or slower. Though the actual danger of blur from camera or subject movement depends on many factors (p. 44), including your own ability to hold the camera steady, you may wish to use the figure "30" as a reference point to gauge the chance of blur.

When a slow shutter speed is unavoidable, use one of the following methods (given in order of increasing steadiness) to prevent blur from camera movement:

- Hold the camera firmly against your face (in horizontal position, place your thumb between camera and face for support), brace your arm(s) against your body, and spread your feet slightly or lean against a tree, etc. Another way is to kneel on one knee and rest your elbow on the other.
- Steady the camera against a post or other firm, non-vibrating support.
- Use a minipod or similar device to prop the camera on a table, ledge, etc.
- Mount the camera on a sturdy tripod.

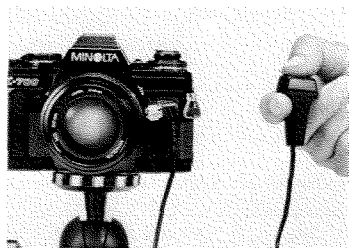

Mounting camera on tripod

For maximum sharpness when making exposures too long to permit hand-holding the camera, as well as for self-timer pictures, mount it on a tripod using the socket on the camera bottom. Release the shutter in one of the ways explained on the next page.

CAUTION

- Do not use excessive force when attaching the camera to a tripod with a screw that extends more than 5.4mm (1/5 in.).

Self-timer

The X-700's electronic self-timer can be used to delay release of the shutter for 10 seconds. To operate it:

1. Mount the camera on a sturdy support, compose your picture, and focus.
2. Set the mode/shutter-speed selector at any setting other than "B", and make sure the film is advanced.
3. Pull the self-timer switch up.
4. To start the timer, press the operating button.

A visual signal and (if main switch is at "ON") audible beeps indicate how much time is left before the self-timer releases the shutter. The self-timer LED blinks and the camera beeps as follows:

First 8 sec.	twice per sec.
Next sec.	eight times
Last sec.	continuously

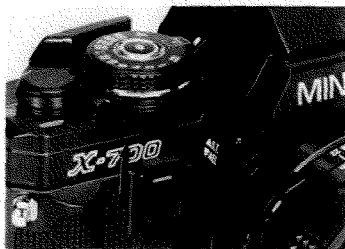

NOTES

- If you wish to cancel the self-timer after it has been started, push the self-timer switch down or turn the main switch off.
- Be sure to turn the self-timer off after the picture has been taken. If you do not, the next picture will also be taken after a 10-sec. delay.
- When taking self-timer pictures in P or A mode, use the eyepiece cap (p. 25).

Other ways of releasing shutter

The shutter can also be released by using one of the following:

- Minolta Remote Cord S (50cm, 20 in.) or Remote Cord L (5m, 16-1/2 ft.)
- Minolta Wireless Controller IR-1 Set (p. 56)
- Minolta Multi-Function Back (p. 55)

The remote cords and cable release should be screwed into the shutter-release socket on the side of the lens mount.

CREATIVE CONTROL OF APERTURE AND SHUTTER SPEED



A

Sometimes you may want to select an aperture so as to obtain a particular effect, such as rendering a certain range in sharp focus or emphasizing a subject against an out-of-focus background. In either case, use the X-700 in A or M mode, setting

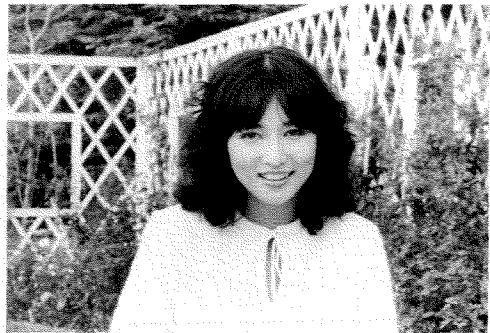

B

the lens at the desired aperture. Small f-numbers yield a shallow field of sharp focus, as in photo A above, while large f-numbers give greater depth of field, as in photo B.

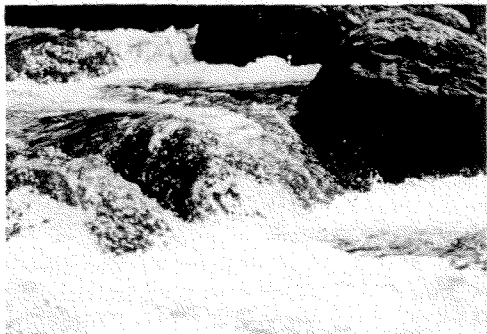

C

At other times, the subject or effect you want may make the shutter speed more important. In A mode turn the aperture ring until the LED next to the desired shutter speed lights, or use M mode to set the speed. Fast shutter speeds such as 1/500 to



D

1/1000 sec. can "freeze" action, as in photo C above. Slow shutter speeds such as 1/2 to 1 sec. can be used to emphasize subject flow or motion (photo D).

FLASH PHOTOGRAPHY

Besides its pentaprism-mounted silicon photocell for ambient light metering, the X-700 has a second cell located in its mirror compartment to measure through-the-lens (TTL) light reflected from the film during flash exposures with PX-series Auto Electroflashes. Used in program TTL autoflash mode with the X-700 and an MD lens set for P mode, this Minolta Direct Autoflash Metering system allows you to simply compose, focus on a subject in flash range, and shoot. The aperture will be automatically set for you by the camera's flash program.

In any-aperture TTL autoflash mode with the X-700 set at "A", you can open the aperture fully up to obtain maximum flash range, or close it down for greater depth of field. Since light is metered through the lens at the taking aperture during exposure, this mode is ideal for autoflash close-ups, bounce flash, 50 and other creative flash techniques.

In both modes, an LED will blink in the viewfinder to indicate if exposure was sufficient, and flash exposures can be lightened or darkened over a wide range by using the camera's exposure-adjustment control.

The table at right summarizes how to use PX and other flash units with the X-700. For specific instructions, see the applicable owner's manual.



Connecting flash units

Cordless clip-on flash units are attached and electrically connected by simply sliding them into the camera's hot shoe. Sync cords of clip-on or bracket-type units must be plugged into the camera's sync terminal.

Bracket-type flash units attach to the camera's tripod socket.

	PX-series Auto Electroflash	X-series Auto Electroflash	Other
Camera connection	Hot shoe (or off-camera cables)	Hot shoe	Hot shoe or sync cord
Flash mode and aperture setting	Controllable by camera's selector: P: program TTL (camera selects aperture by flash program) A: any-aperture TTL (user selects aperture to control flash range and depth of field) 1-1000, B: manual flash (aperture determined by distance)	Selected on flash: Auto: by on-flash sensor at designated aperture(s) Manual: aperture determined by distance	
X-sync shutter speed	Shutter automatically releases at 1/60 if flash charged (except when camera set at "B")		Electronic flash: 1 to 1/60, B, M, MF, or FP bulb: 1 to 1/15, B
Flash-ready signal	LED next to "60" blinks at 2Hz (and "A" or "M" LED goes out in A or M mode); monitor lamp on flash		Monitor lamp on flash
If shutter released before flash charged:	Photo taken without flash at existing settings		Flash may or may not fire
Flash-distance check (FDC) signaling	"60" LED blinks at 8Hz (in TTL); FDC lamp on flash	FDC lamp on models 320X, 132X only	FDC lamp on models 320, 128 only
Exposure-adjustment control	Usable in P and A modes (viewfinder +/- LED goes out even when in use)	Not usable	Not usable

Auto Electroflash 360PX also has on-flash sensor for auto control at any of 3 apertures depending on film speed.
Auto Electroflash CLE is usable for any-aperture TTL flash in A mode or for manual flash.



ACCESSORIES (Minolta Program System)

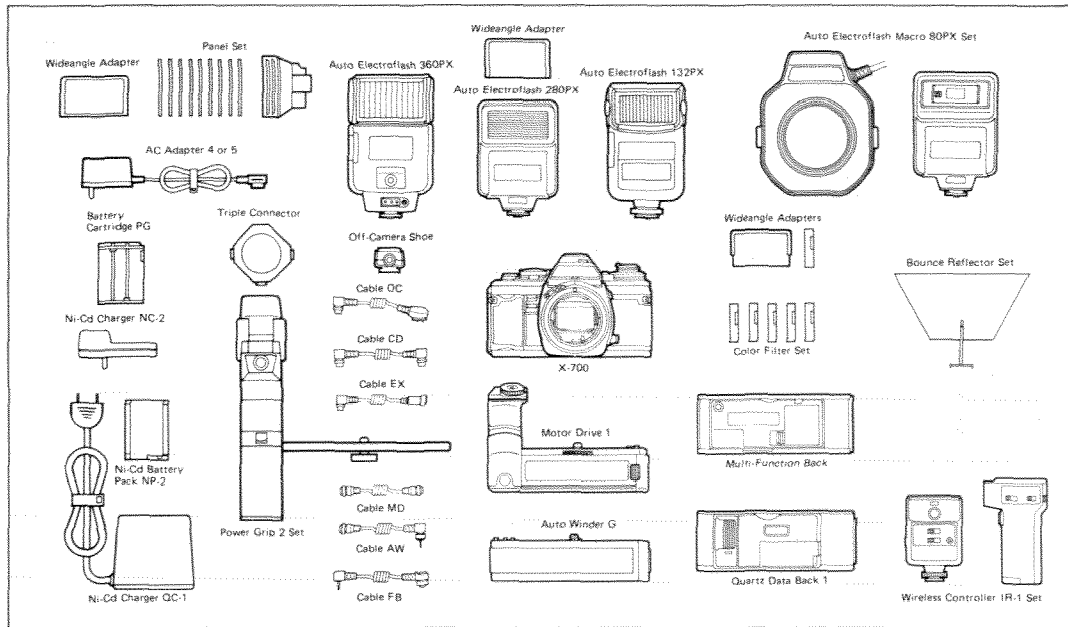

See system guidebook in camera box for lenses and other accessories.



AUTO ELECTROFLASH 280PX, 132PX, 360PX, MACRO 80PX SET

With one of these flash units attached, the X-700's Direct Autoflash Metering system provides through-the-lens (TTL) off-film flash control in program (P) mode or any-aperture (A) mode. Viewfinder flash-ready signaling, auto sync-speed setting, and sufficient-exposure confirmation are other features that make them extremely simple to use.

The compact, lightweight 280PX has energy-saving thyristor circuitry and a power-level selector enabling 2fps winder/motor-drive sync.

The inexpensive yet versatile 132PX gives you the option of vertical bounce and automatically turns itself off when disconnected.

Among the many handy features of the top-of-the-line 360PX are: horizontal/vertical bounce, variable GN/power control (enabling sync at up to 2fps), auto power switchoff, terminals for off-camera cables and direct auto charge control by the Multi-Function Back in time-lapse photography, and a built-in auto sensor for use with other cameras.

The lens-mounted Macro 80PX Set (used in A mode) has four flashtubes that can be independently switched on or off to control lighting of close-up and macro subjects.

A wide range of accessories for PX flash units expands their usefulness for creative flash photography. Designed for the 280PX and 360PX, Power Grip 2 features well-balanced handling, sync at up to 3.5fps, auto power switchoff, auto charge control (with Multi-Function Back), and bounce flash at a great range of angles. Filter panel sets and a bounce reflector are available for the 360PX and 132PX, and an AC adapter for the 360PX and Macro 80PX Set. Cables and connectors enable simple, accurate TTL autoflash operation for close-up, directional, and multi-flash techniques.



MULTI-FUNCTION BACK

The quartz/microcomputer-controlled Multi-Function Back connects cordlessly to the X-700 in place of its regular back to perform a variety of camera-control and data-imprinting functions. By simply pressing keys while viewing its liquid-crystal display, you can set it for time-lapse photographs at a huge range of intervals, automatically timed long exposures, and/or multi-frame sequences. The quartz timer and auto calendar enable recording the time accurate to the second, or the year/month/day in any of three orders. Or you can set the imprinter to record any six-digit code number, to consecutively number each frame, or for no imprinting. Manually controlled imprinting before or after taking the picture is also possible, and data exposure can be selected at any of six levels to match the sensitivity of the film in use.

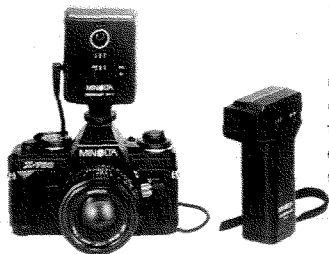
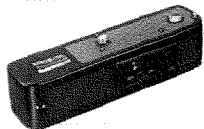

MOTOR DRIVE 1 and AUTO WINDER G

With Motor Drive 1 attached, you can capture the action with single-frame or continuous operation at either 2 or 3.5 frames per second. The comfortable handgrip has two operating buttons, each with a Minolta "touch switch", enabling full viewfinder readout for either horizontal or vertical framing.

Auto Winder G lets you focus full attention on the creative aspects of photography by freeing you from winding the film after each picture. Continuous sequences up to 2fps are also possible by holding the camera's operating button down.

Both units are designed to attach quickly and easily without access caps to remove or store. Their film-advance mechanisms stop automatically at the end of the roll, and film can be easily loaded and unloaded without removing the units.

WIRELESS CONTROLLER IR-1 SET

The IR-1 infrared transmitter/receiver set lets you trigger the X-700 from up to 60m (about 200 ft.) away for remote-controlled single-frame exposures, continuous sequences, or time exposures. When used with extra receivers, the three-channel transmitter enables independent operation of up to three cameras or groups of cameras, or simultaneous operation of an unlimited number of cameras.

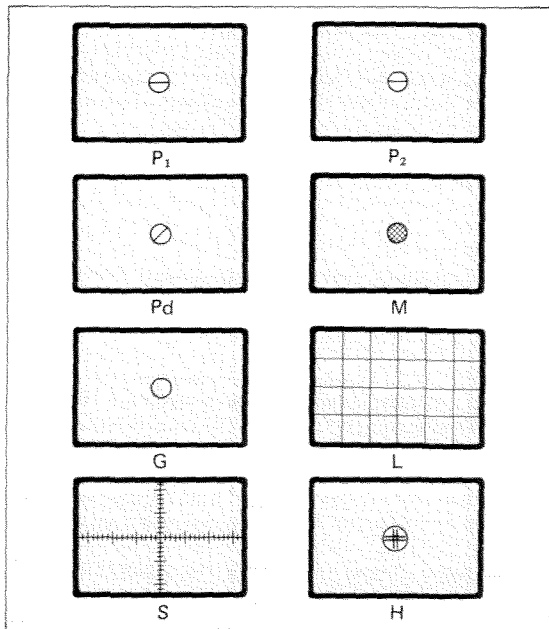

OPTIONAL FOCUSING SCREENS

The X-700's standard focusing screen can be replaced by any of eight optional Acute Matte screens at authorized Minolta service facilities. Types and usages are as follows:

PM: horizontal split/microprism band; standard type (not shown); general photography

P₁: horizontal split; general photography

P₂: horizontal split; general photography with f/2.8 or larger max. aperture lenses

P_d: diagonal split; general photography

M: microprism spot; general photography

G: matte field only; general, close-up, and telephoto photography

L: matte field with grid; general photography

S: horizontal and vertical measuring scales; general, macro-, micro-, and astrophotography

H: clear spot with engraved double cross; macro-, micro-, and astrophotography

Interchangeable lenses and other SLR system accessories are shown in the system guidebook included in the camera box.

TECHNICAL DETAILS

Type: Electronically governed 35mm single-lens reflex AE camera

Exposure-control modes: Fully programmed ("P"), aperture-priority automatic ("A"), and metered manual ("M")

Lens mount: Minolta SLR bayonet of integrally lubricated stainless steel (54° rotating angle); coupling for full-aperture metering, finder display input, and automatic diaphragm control, providing programmed or aperture-priority auto operation with Minolta MD lenses, aperture-priority auto operation with MC and other Minolta SLR interchangeable lenses/accessories; spring-return button for depth-of-field preview or stop-down meter readings with other than MD or MC lenses (standard lenses: MD 50mm f/1.2, f/1.4, f/1.7)

Exposure control and functions: Low-voltage, low-current computer circuit incorporating quartz crystal for sequential control to 1/30,000-sec. accuracy, large-scale ICs, samarium-cobalt impulse-release magnets, and linear-resistance inputs) varies both aperture and shutter speed steplessly according to special "faster-speed" program (see p. 30) in P mode, or varies shutter speed steplessly according to aperture set in A mode, to yield proper exposure for the film

speed and exposure adjustment set; auto-exposure range: EV 1 to EV 18 (e.g., 1 sec. at f/1.4 to 1/1000 at f/16) at ISO 100/21° with f/1.4 lens; AE-lock device holds meter reading for exposure at that value regardless of subject-brightness changes

Shutter: Horizontal-traverse focal-plane type; electronically controlled stepless speeds 1/1000 to 4 sec. set automatically with endlessly rotatable selector dial locked at "P" or "A" setting or fixed speeds 1 to 1/1000 sec. or "B" (bulb) set manually at detented dial indications; electromagnetic shutter release locks when voltage too low for proper operation

Metering: TTL center-weighted averaging type, by silicon photocell mounted at rear of pentaprism for available light, measured full aperture for normal finder display, then at taking aperture for programmed/automatic-exposure setting/determination or stop-down display; by another SPC mounted with optic in side of mirror compartment for TTL off-film Direct Autoflash Metering at taking aperture during exposure to control burst duration of PX-series flash units

Film-speed range: ISO 25/15° to 1600/33° set by ASA dial that locks at 1/3-EV increments

Exposure-adjustment control: Up to ± 2 EV continuous adjustment of P, A, or M exposure by dial that locks at zero position and each 1/2-EV setting

Mirror: Triple-coated oversize instant-return slide-up type

Viewfinder: Eye-level fixed pentaprism type showing 95% of 24x36mm film-frame area; magnification: 0.9X with 50mm standard lens focused at infinity; power: -1D, adjustable with accessory snap-on eye-piece lenses; Fresnel-field focusing screen having artificially regular-patterned matte field plus central split-image horizontally oriented focusing aid surrounded by microprism band, interchangeable with Type P1, P2, Pd, M, G, L, S, or H screens at authorized Minolta service stations; visible around frame: mode indication (P, A, or M), shutter-speed scale (1, 2, 4, 8, 15, 30, 60, 125, 250, 500, and 1000) with LED setting indication, triangular over-/under-range LED indicators blinking at 4Hz, flash-ready signal (LED next to "60" blinking at 2Hz), FDC signal ("60" LED blinking at 8Hz for 1 sec. after correct flash exposure), mis-set lens warning (mode indication blinking at 4Hz) in P mode, battery check (by glowing of any LED when operating button touched or pressed slightly), f-number set with MD or MC lenses, and exposure-adjustment engaged indica-

tion (LED blinking at 4Hz); display and metering activated by normal finger contact or slight pressing of operating button and continue for 15 sec., except go out after shutter release

Flash sync and control: Hot shoe and PC terminal for X sync; camera-control contact on hot shoe for flash-ready signaling and automatic setting of shutter at 1/60 sec. (except when mode/shutter-speed selector set for sync at "B") with PX and X flash units; other electronic units synchronize at 1/60 sec. and slower manual speeds or "B" setting; Class MF, M, and FP flashbulbs, at 1/15 sec. or slower settings; second contact on hot shoe for burst control by Direct Autoflash Metering with PX units

Film advance: Manual: by lever with single 130° stroke after 30° unengaged movement; motorized: through built-in coupler key with accessory Motor Drive 1 or Auto Winder G; release button for rewind on camera bottom; advancing-type frame counter; Safe Load Signal indicates film loading and advancing condition

Power: Two 1.5v alkaline-manganese (LR44: Eveready A-76 or equiv.), two 1.55v silver-oxide (SR44: Eveready S-76, EPX-76, or equiv.), or one 3v lithium (CR-1/3N) cell(s) contained in camera base power both programmed/auto exposure control and manual operation; three-position main switch with indication for off, on, or on with audible piezoelectric slow-speed warning and self-timer operating indication; battery check by touching or slightly pressing operating button (LEDs do not light when cells approach exhaustion); shutter will not release when voltage too low for proper operation

Self-timer: Electronic for 10-sec. delay, with operation indicated by camera-front LED that blinks at 2Hz for 8 sec., then 8Hz for 1 sec., then remains on until shutter releases, plus simultaneous audible indication when main switch in appropriate position; engaged by switch on body, cycle started by pushing operating button, cancelable anytime before release

Other: Audible 4Hz piezoelectric warning when finder speed indication is 1/30 sec. or slower whenever finger contacts "touch switch" normally or presses operating button slightly with main switch appropriately set; integral front handgrip; detachable back with integral handgrip, memo holder, and ISO (DIN-ASA) table; positive 4-slot take-up spool; remote shutter-release socket

Size and weight: 51.5 x 89 x 137mm (2 x 3-1/2 x 5-3/8 in.), 505g (17-13/16 oz.) without lens and/or power cells

Standard accessories: Carrying strap with slide-on spare battery holder and eyepiece cap

Optional accessories: Auto Electroflash 360PX, 280PX, 132PX, Macro 80PX Set, off-camera cables and connectors, Power Grip 2, sec.; Multi-Function Back; Motor Drive 1, Auto Winder G; Wireless Controller IR-1 Set; MD, MC, and other Minolta interchangeable lenses and applicable Minolta SLR system accessories

Specifications subject to change without notice

STORAGE

- If the camera is not to be used for more than two weeks, the batteries should be removed.
- It is advisable to operate the film-advance lever and release the shutter once or twice from time to time during extended storage.

- If the camera is to be stored for a long period of time, the body and lens should be returned to their original packing and kept in a cool, dry place away from dust or chemicals, preferably in an airtight container with a drying agent such as silica gel.

Minolta Co., Ltd.	3-13, 2-Chome, Azuchi-Machi, Chuo-Ku, Osaka 541-8556, Japan
Minolta GmbH	Kurt-Fischer-Strasse 50, D-22923 Ahrensburg, Germany
Minolta France S.A.	365 Route de Saint-Germain, F-78420 Carrieres-Sur-Seine, France
Minolta (UK) Limited	7 Tanners Drive, Blakelands, Milton Keynes, MK14 5BU, England
Minolta Austria Ges. m.b.H.	Amalienstrasse 59-61, A-1131 Wien, Austria
Minolta Camera Benelux B.V.	Zonnebaan 39, P.O. Box 6000, NL-3600 HA Maarssen, The Netherlands
Belgium Branch	Kontichsesteenweg 38, B-2630 Aartselaar, Belgium
Minolta (Schweiz) AG	Riedstrasse 6, CH-8953 Dietikon, Switzerland
Minolta Svenska AB	Albygatan 114, S-171 54 Solna, Sweden
Finland Branch	Niittykatu 6 PL 37, SF-02201 Espoo, Finland
Minolta Portugal Limitada	Av. do Brasil 33-A, P-1700 Lisboa, Portugal
Minolta Corporation	
Head Office	101 Williams Drive, Ramsey, New Jersey 07446, U.S.A.
Los Angeles Branch	11150 Hope Street Cypress, CA 90630, U.S.A.
Minolta Canada Inc.	
Head Office	369 Britannia Road East, Mississauga, Ontario L4Z 2H5, Canada
Vancouver Branch	230-3771 Jacombs Road, Richmond, B.C. V6V 2L9, Canada
Minolta Hong Kong Limited	Room 208, 2/F, Eastern Center, 1065 King's Road, Quarry Bay, Hong Kong
Minolta Singapore (Pte) Ltd.	10, Teban Gardens Crescent, Singapore 608923
Shanghai Minolta Optical Products Co., Ltd.	368 Minolta Road, Songjiang, Shanghai, China

