

Manual Fill-Flash

In P mode even though the camera usually determines automatically when flash is necessary, you can also manually fire the built-in flash or attached accessory flash at any time. This will help reduce harsh shadows that occur with strong lighting.

To fire the flash manually:

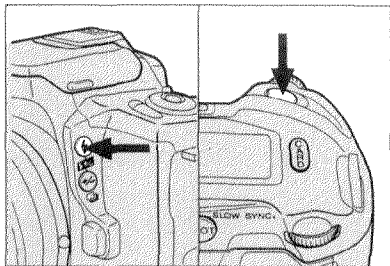



Make sure the built-in flash is up or the attached, dedicated flash is on. Then, while pressing the flash-control button, press the shutter-release button all the way down to take the picture.

A, S, AND M MODE FLASH

In A, S, or M mode when the built-in flash is up or an accessory flash is attached and on, the flash will fire each time you take a picture. The camera uses TTL control to ensure proper exposure. Camera operation in these three exposure modes with flash is the same as without flash except you cannot use shutter speeds faster than the camera's top x-sync speed, 1/200 second.

- If the 5400HS flash unit is attached, High-Speed Sync (HSS) Flash is available and any shutter speed up to 1/8000 second can be selected.  appears in the viewfinder and body data panels when it is selected. See the 5400HS instruction manual for details.

Viewfinder Signals

- The flash-on indicator  appears to indicate that the flash will fire with the next shutter release.
- The flash signals  (pre-flash selected) will light when the flash is charged.
- After you release the shutter, if the flash output was sufficient to provide a correct exposure, the flash signals will blink.

SLOW-SHUTTER SYNC



With slow-shutter sync



Without slow-shutter sync

In P and A modes, slow-shutter sync sets a slower shutter speed to increase the background or ambient lighting exposure in a flash picture. Flash output will be automatically decreased to maintain a correct exposure of your subject.

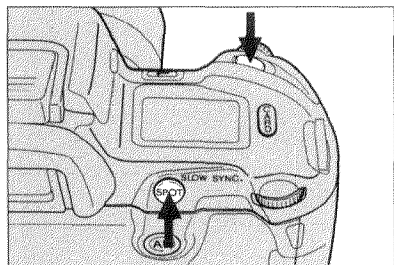

1. Frame your subject.
2. While pressing the spot button, press the shutter-release button all the way down to take the picture.

- If the background is bright or a large aperture is set, the shutter speed may not be reduced.
- The flash signals in the viewfinder data panel will blink if the flash output was sufficient to provide a correct exposure.
- If the shutter speed becomes too slow to allow sharp, hand-held pictures after you press the spot button, use a tripod.

FLASH COMPENSATION

This function enables you to bias the flash output of the built-in flash or an attached accessory flash + or -3 stops.

To set a compensation factor:

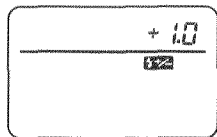
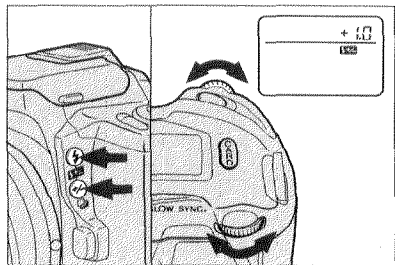

1. While simultaneously pressing the exposure-compensation and flash-control buttons, turn either control dial until the compensation factor you want appears in the viewfinder and body data panels.
2. Release the buttons to enter the factor.

- The flash compensation reminder remains in the viewfinder and body data panels. To check the amount of compensation at any time, simultaneously press the exposure-compensation and flash-control buttons.

- To cancel flash compensation, set 0.0.

REMOTE-WIRELESS OFF-CAMERA FLASH CONTROL

When used with specified xi flash units, this camera offers you the flexibility of remote/wireless off-camera flash control with TTL flash metering.

Setting Control Channel

The flash unit has more than one control channel so you will not interfere with other flash units in remote/wireless mode. To change the control channel, slide the control channel selector located in the battery chamber of the flash. After changing the control channel, attach the flash to the camera and press the shutter-release button partway down to set the camera to the same channel.

Standard Remote/Wireless Operation

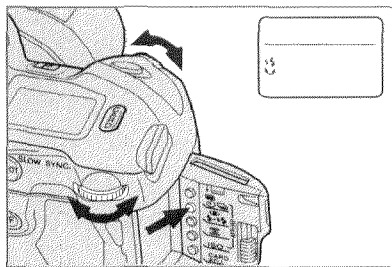

1. Attach the flash to the camera and turn it on.
2. Open the card door and press the flash-mode button.
3. Turn either control dial until  blink alternately in the body data panel.
4. Press the shutter-release button partway down to enter your selection.

● The accessory flash can also be set without attaching it to the camera. With the 3500xi flash unit, press the ON/OFF button so the flash turns on and hold it until the wireless lamp glows. For setting other flashes, see their respective instruction manuals.

5. Remove the flash and position it and the camera according to the chart.
- Make sure the AF illuminator on the flash is pointing at the subject.
 - The off-camera flash may not detect the control signals if it is placed behind the subject.

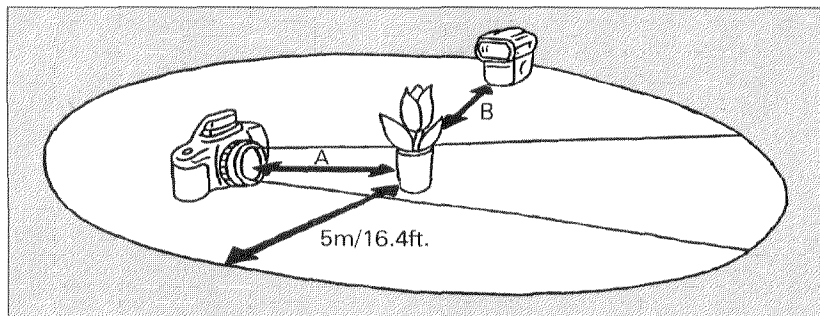

Aperture	Camera-Subject Distance m/ft. (A)		Flash-Subject Distance m/ft. (B)	
	ISO 100	ISO 400	ISO 100	ISO 400
f/2	2-5m/6.6-16.4 ft.	4-5m/13.2-16.4 ft.	2-5m/6.6-16.4 ft.	4-5m/13.2-16.4 ft.
f/2.8	1.4-5m/4.6-16.4 ft.	2.8-5m/9.2-16.4 ft.	1.4-5m/4.6-16.4 ft.	2.8-5m/9.2-16.4 ft.
f/4	1-5m/3.3-16.4 ft.	2-5m/6.6-16.4 ft.	1-5m/3.3-16.4 ft.	2-5m/6.6-16.4 ft.
f/5.6	1-5m (4m)/3.3-16.4 ft. (13.1 ft.)*	1.4-5m/4.6-16.4 ft.	0.7-4m/2.3-13.1 ft.	1.4-5m/4.6-16.4 ft.
f/8	1-5m (2.8m)/3.3-16.4 ft. (8.8 ft.)*	1-5m/3.3-16.4 ft.	0.5-2.8m/1.6-8.8 ft.	1-5m/3.3-16.4 ft.
f/11	1-5m (2m)/3.3-16.4 ft. (6.6 ft.)*	1-5m/3.3-16.4 ft.	0.4-2m/1.3-6.6 ft.	0.7-4m/2.3-13.1 ft.

*Values in parentheses indicate the maximum distance for wireless/remote ratio control (pp. 33, 35).

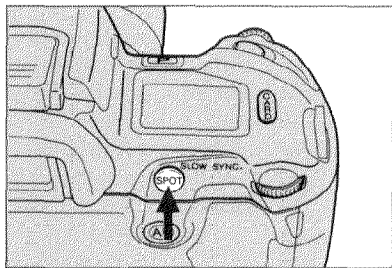
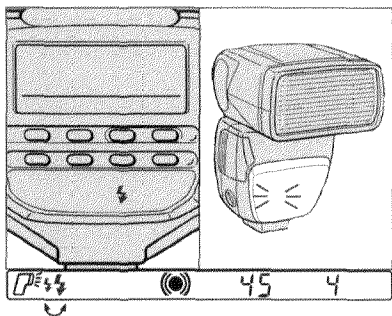

6. Lift the built-in flash and wait until both the off-camera flash and built-in flash are charged.

- In remote/wireless mode, the off-camera flash's AF illuminator will blink when the flash is charged. When the built-in flash is charged,  will appear and blink alternately in the camera's viewfinder data panel.

7. Press the spot button to test-fire the off-camera flash and wait again until both flashes are fully charged.

8. Press the shutter-release button all the way down to take the picture.

- The flash signals in the viewfinder data panel will blink if the flash output was sufficient to provide a correct exposure.

- When modeling-flash mode is selected on the 5400HS flash unit, pressing the spot button activates the modeling flash.
- You can control any number of off-camera flash units set to remote/wireless mode.
- Because the signal that fires the off-camera flash is a small burst from the built-in flash, reduce the brightness of your surroundings as much as possible.

Canceling Remote/Wireless Flash Mode

- To cancel remote/wireless flash mode on the camera, open the card door and press the flash-mode button. Then, turn either control dial to select another flash mode.
- To cancel remote/wireless flash mode on the 3500xi flash unit, press the ON/OFF button so the flash is on and hold it until the wireless lamp extinguishes. For canceling remote/wireless flash mode on other flash units, see their respective instruction manuals.

Remote/Wireless Slow-Shutter Sync

In remote/wireless slow-shutter sync mode, the camera sets a slow shutter speed and reduces the flash output to maintain a correct exposure.

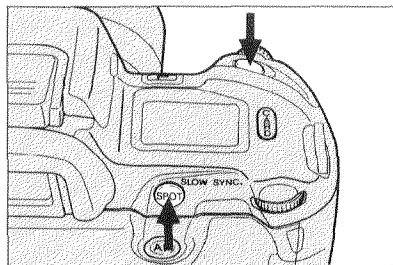

1. Press and hold the spot button. The off-camera flash will first fire a test burst. Do not release the spot button until after you have taken the picture.
2. Continue to hold the spot button while the flashes are charging. When  appears in the camera's viewfinder data panel, and the AF illuminator of the off-camera flash blink, press the shutter-release button all the way down to take the picture.

Wireless/Remote Ratio Control

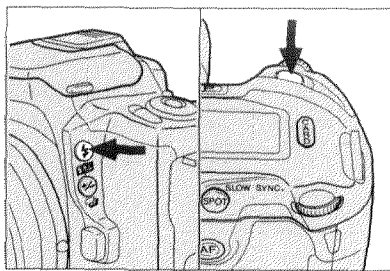

In remote/wireless mode, the off-camera flash and built-in flash can work together to provide a 2:1 lighting ratio on your subject. While pressing the flash-control button, press the shutter-release button all the way down to take the picture. The off-camera flash will provide 2/3 of the exposure and the built-in flash will add the remaining 1/3.

Wireless/Remote Ratio Control with the Wireless Remote Flash Controller, and Multiple Off-Camera Flash Units

When the Wireless Remote Flash Controller is attached to the 700si, a 2:1 or 1:2 lighting ratio is available between two flashes placed off-camera. You can obtain 2:1 and 1:2 lighting ratios using the 5400HS and/or the 5400xi. If you are using one 5400HS or 5400xi and one 3500xi, the only ratio possible is 5400xi/5400HS [1]:[2] 3500xi. Refer to the Wireless Remote Flash Controller instruction manual and the 5400xi or 5400HS instruction manual for details.

ADDITIONAL FEATURES

METERING INDEX

The table below summarizes the situations in which the metering index will appear in the viewfinder screen.

	When the Index Appears	0 Position on Index	Pointer
P / A / S	14-Segment Honeycomb-Pattern metering is selected and the exposure-compensation button is pressed	Exposure calculated by center-weighted average metering	Current exposure settings*
	Center-weighted average metering is selected and the exposure-compensation button is pressed	Un-biased center-weighted average reading	Amount of compensation
	Spot metering is selected and the exposure-compensation button is pressed	Un-biased spot reading	Amount of compensation
	While the spot button is pressed	Locked spot reading	Difference in exposure required by area currently inside the spot circle
	In manual exposure mode	Exposure calculated by camera using current metering mode	Difference in exposure provided by manual camera settings

*This will include any exposure compensation you have set manually in addition to the adjustment made by honeycomb-pattern metering for backlit, spotlight, or off-center subjects.

- The pointer will blink if the indicated value is greater than +3 EV or less than -3 EV.

MEMORY

With Memory you can store a wide range of your most-often-used camera settings or settings for a particular event (listed below) and recall them at any time by pressing the memory recall button. To return to the camera's programmed settings, press the program-reset button (see p.24).

Functions	Settings that can be stored in Memory
Exposure mode	P/A/S/M
Aperture settings	f/1.0-f/64 (depends on lens)
Shutter-speed settings	1/8000 – 30 sec. or BULB
Film-drive mode	Single-frame advance, Continuous advance, Double exposure, or Self-timer
Flash mode	Pre-flash on, Pre-flash off, or Remote/Wireless mode
Exposure compensation	+ / – 3.0 EV in 0.5 EV steps
Flash compensation	+ / – 3.0 EV in 0.5 EV steps
Metering mode	Honeycomb-pattern, Spot, or Center-weighted average metering
Focus area	Wide or one of the four local focus areas
Shutter-release mode	Autofocus or Release priority

To store settings in Memory:

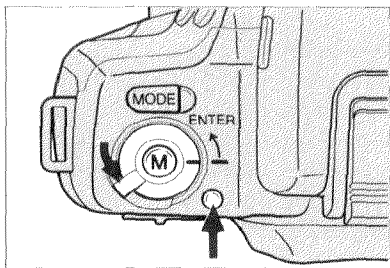

1. Make all the camera settings you want to save (see the chart on the previous page).
2. While pressing the memory-switch release, turn the memory switch to ENTER.
 - **MEMORY** will appear in the body data panel.
3. Release the memory switch. It will return to its locked position.

- When you store your settings in Memory, shutter-speed, aperture, exposure compensation, and flash compensation values will not appear in the data panel, but they will be memorized.

To recall camera settings in Memory:

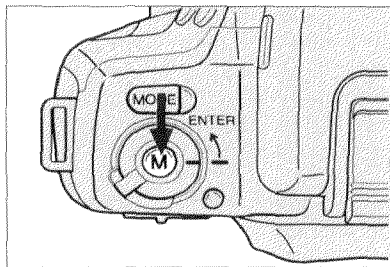

Press the memory recall button.

- When you want to return to the camera's *programmed* settings, press the program-reset button (see p.24).

SELF-TIMER

The electronic self-timer will delay release of the shutter for approximately 10 seconds after you press the shutter-release button.

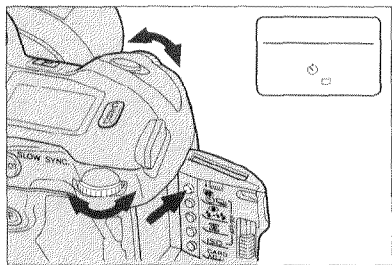

To activate the self-timer:



1. Open the card door and press the self-timer/drive-mode button.
2. Turn either control dial until  appears in the body data panel.
3. Press the shutter-release button partway down to enter your selection.
4. Compose your scene and press the shutter-release button all the way down to start the timer.

- If you are not looking through the viewfinder when you press the shutter-release button, light entering the eyepiece may affect the camera's automatic exposure settings. To prevent this, attach the eyepiece cap before you start the timer (see page 10).
- The AF illuminator will blink twice per second until the shutter releases.
- To cancel the self-timer, slide the main switch to LOCK.
- The self-timer is canceled automatically after shutter-release.

FILM DRIVE

The camera has single-frame and continuous film advance. In single-frame mode  , the camera makes one exposure and advances the film one frame each time you press the shutter-release button. In continuous mode  , the film is advanced at up to 3 frames per second while you hold the shutter-release button down. When you use continuous and autofocus mode, focus will be checked and adjusted between each exposure to ensure that moving subjects remain sharply focused.

To change the film-drive mode:

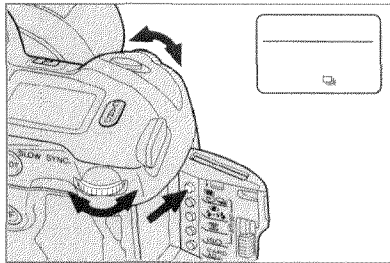

1. Open the card door and press the self-timer/drive-mode button.
2. Turn either control dial until the indicator for the mode you want appears in the body data panel.
3. Press the shutter-release button partway down to enter the mode you selected.

● Because the camera has focus-priority shutter release, the actual frame rate will depend on the speed of your main subject. To ensure the maximum speed of the drive mode you select, you can use release-priority mode. See page 77 for details.

DEPTH-OF-FIELD PREVIEW

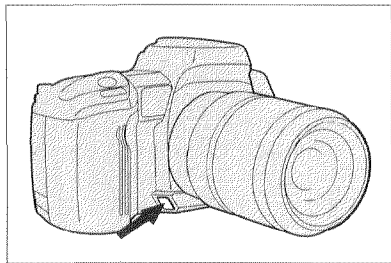
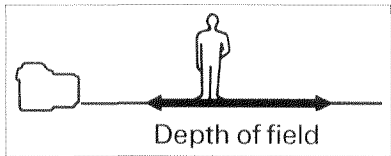

Depth of field is the distance in front of and behind the point on which the lens is focused which will also appear sharp in the final image. To check how much of your scene will appear in focus, press the depth-of-field preview button. This will stop the lens down to the aperture which appears in the data panel. The image in the viewfinder screen will darken when you press the button; the smaller the aperture, the darker it will be.

- The exposure settings cannot be changed while you are pressing the depth-of-field preview button.

RELEASE PRIORITY

The 700si has focus-priority shutter release. With it, the shutter will not release if the subject is not in focus and the camera is in autofocus mode. This helps ensure a high percentage of sharp photographs when you are shooting a moving subject and using continuous-drive mode. This also makes the actual speed of film advance dependent on the speed of your subject.

In release-priority mode, the shutter will release even if the subject is not sharply focused. Continuous autofocus and predictive focus control will continue to operate, but priority will be placed on maintaining the top speed of the drive mode.

When the 700si is manufactured, it will be set to focus-priority mode.

To select release-priority mode:

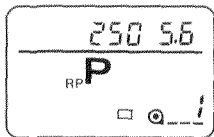
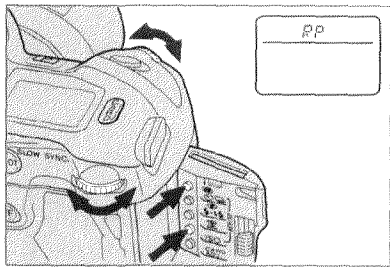

1. Open the card door and simultaneously press self-timer/drive-mode and ISO buttons.

- "AFP" will appear in the body data panel.

2. Turn either control dial until "RP" appears in the body data panel.

3. Press the shutter-release button partway down to enter your selection.

- The release priority indicator **RP** appears in the body data panel.

- When you set release priority, the performance of multi-/omni-dimensional predictive focus control may diminish slightly.

To return to focus-priority mode, repeat 1 through 3 above.

- "AFP" will appear in the body data panel while setting.

IMAGE-SIZE LOCK

Image-Size Lock is available with xi-Series lens. It automatically adjusts the lens' focal length to maintain the size of the main subject's image in the viewfinder.

To use Image-Size Lock:

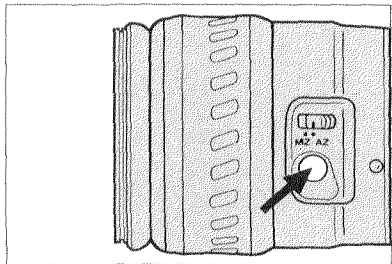

1. Make sure the eye-start switch is set to ON.
2. Compose your subject within the focus area, then press and hold the lens-function button on an xi-Series lens. ISL On will appear in the viewfinder data panels while Image-Size Lock is operating until you press the shutter-release partway down. It will then be replaced by shutter-speed and aperture settings.
3. Press the shutter-release button all the way down whenever you want to take a picture.

- To turn off Image-Size Lock, release the lens-function button.
- Image-Size Lock is limited by the focal length range of the lens you are using. If either end of the lens focal length range is reached while image-size lock is operating, the lens will stop zooming, but ISL ON will continue to be displayed in the viewfinder data panel. If your subject comes back into range, Image-Size Lock will resume operation.
- Image-Size Lock may not be able to accurately track high-speed subjects. If your subject is moving too fast, the image size may not remain constant, but ISL ON will continue to be displayed in the viewfinder data panel. In the following situations, ISL -- will appear in the viewfinder data panel when you press the lens-function button and Image-Size Lock will not function:
 - If your subject is too small and/or too far away for the camera to lock on to it.
 - If the camera cannot focus on your subject (see Special Focusing Situations, p. 36).
 - If the lens is initially set to a focal length shorter than 50mm.

PANORAMA INDICATOR



When you insert the Panorama Adapter in the back of the camera, you must set the camera's viewfinder frame for the panorama format. If you do not insert the adapter, you can use the panorama frame to compose your shots and later have them printed as panoramic pictures.

To turn on the panorama indicator:

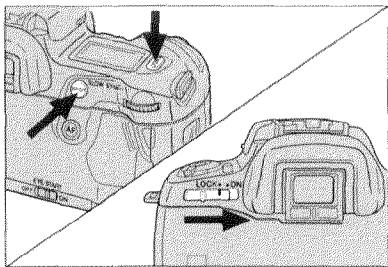

Simultaneously press the card and AF buttons while sliding the main switch from LOCK to ON. The panorama indicator will appear in the viewfinder.

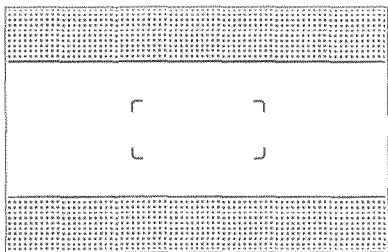

- To reset the standard frame, repeat the procedure.
- Exposed film and printed pictures will be full frame, not panoramic.

APPENDIX

ACCESSORY INFORMATION

If you already have own MINOLTA accessories, check their compatibility before using them with your 700si.

1. LENS

- All Minolta AF lenses can be used with 700si.
- Manual focusing lenses (MD or MC) cannot be attached to the 700si.
- Shadowing on the bottom of your picture may occur when the built-in flash is used together with a lens listed below. Before using any of these lenses with the built-in flash, check with the nearest MINOLTA Service Facility for the conditions of their use.

AF 28-85mm f/3.5-4.5 AF 28-135mm f/4-4.5 AF 28-70mm f/2.8 G

- The built-in flash cannot be used under any conditions with the following lenses.

AF 300mm f/2.8 APO TELE AF 300mm f/2.8 APO TELE (N)

AF 600mm f/4 APO TELE AF 600mm f/4 APO TELE (N)

- Keep in mind, too, that the built-in flash provides coverage for lenses with focal lengths no wider than 24mm.

2. FLASH

- All Minolta i- and xi-Series flash units can be used, as well as the Program Flash 5400HS.
- Flash Shoe Adapter FS-1100 must be used to attach an AF-series flash (Program/Maxxum Flash 4000AF, 2800AF, 1800AF, 1200AF Macro) to your 700si.

When used with the 700si, these units fire whenever a picture is taken, regardless of the exposure mode selected. In all exposure modes TTL flash control will operate.

ACCESSORIES

3. CARDS

	With 700si	Additional Restrictions			
		Exposure Bracketing	Double Exposure	Memory	Focus Lock with AF button
Travel	1,2	○	○	15	○
Child	○	○	○	15	16,17
Sports action	○	○	○	15	17,18
Sports action 2	○	○	○	15	17,18
Portrait	○	○	○	15	○
Automatic depth control	1	○	○	15	19
Closeup	○	○	○	15	○
Panning	3	—	○	15	18
Intervalometer	○	—	○	○	○
Background priority	4	○	○	15	○
Multiple exposure	5,6	—	—	20	○
Exposure bracketing	5,7	—	—	21	○
Flash bracketing	5,8	—	—	22	○
Bracketing 2	8	—	—	22	○
Data memory	5	○	○	○	○
Data memory 2	○	○	○	○	○
Fantasy effect	9	—	○	15	○
Fantasy 2	10	—	○	15	23
Automatic program shift	5,11	—	—	15,21	○
Auto shift 2	○	—	—	21	○
Multi spot memory	12,13	○	○	24	○
Highlight/shadow control	12	○	○	24	○
A/S mode	×	×	×	×	×
Customized function xi	14	○	○	○	○
Customized function	×	×	×	×	×

O: can be used.

X: cannot be used.

- : cannot be used. Card function overrides the camera function. "Card" blinks in the body data panel.

1 to 24: can be used with the conditions listed below.

1. In release priority, the shutter will not release unless the subject is in focus. Continuous film advance is not recommended.
2. ASZ does not function.
3. Metering index can be used to monitor your panning skill. If the indicator is to the + side of the index, tracking is smooth.
4. Metering index can be used to select the background sharpness. If the indicator is to the + side of the index, both near and far objects should appear sharp in the final image.
5. Settings must be made with front control dial.
6. The aperture is fixed when the camera is being used without flash during fade-in/fade-out in M mode.
7. The aperture is fixed when bracketing in M mode.
8. With flash bracketing, exposure adjustment and frame number for the next frame will appear in the body data panel when you take the camera away from your eye.
9. Focus priority is recommended. If you use release priority, make sure that the subject is in focus before you release the shutter. Otherwise, the fantasy effect may not be obtained. Continuous film advance is not recommended.
10. In release priority, the shutter will not release unless the subject is in focus.
11. The starting point of the exposure series cannot be changed from the settings chosen by Expert Program Selection.
12. When you insert this card, spot metering is automatically activated.
13. The number of areas measured will appear in the body data panel when you take the camera away from your eye.
14. When you select metering method in personal program mode, select either honeycomb-pattern or center-weighted average metering.

-
15. The card's programmed-autoexposure mode will remain selected even when the memory-recall button is pressed.
 16. APZ does not function.
 17. If you press the AF button, the camera will focus once and lock.
 18. When this card is activated, the camera is in continuous AF; however, if you press the AF button, the camera will focus once and lock.
 19. Only one frame can be exposed while the AF button is pressed. You have release the AF button before you can take a second picture.
 20. Double-exposure mode cannot be stored in Memory.
 21. Continuous-frame film advance will remain selected even when the memory-recall button is pressed.
 22. Single-frame advance will remain selected even when the memory-recall button is pressed.
 23. When multi-exposure fantasy mode is selected, the second exposure will not be made until the AF button is released.
 24. Spot-metering mode will remain selected even when the memory-recall button is pressed.

4. OTHER

- Control Grip CG-1000 and Data Receiver DR-1000 cannot be used with 700si.

TECHNICAL DETAILS

Type: 35mm SLR with built-in flash and expert control of autofocus (AF) and autoexposure (AE)

Lens Mount: Minolta A-type bayonet mount

Eye-Start System: AF and AE automatically activated by combination of eyepiece sensors and grip sensors; Can be selected and canceled by eye-start switch

AF System: Minolta's through-the-lens (TTL) phase-detection system with four CCD sensors; Activated by eye-start, or if eye-start is canceled, by pressing the shutter-release button partway down; Omni-/Multi-dimensional Predictive Focus Control; Built-in AF illuminator automatically activated in low-light/low-contrast conditions; AF sensitivity range: EV -1 to 18 (at ISO 100 in ambient light); AF illuminator range: 0.7 to 7 m (based on Minolta's standard test methods); Focus lock and local focus area selection available; Manual focus selectable

Metering: TTL-type; 14-segment honeycomb-pattern silicon photocell (SPC); Automatically activated by eye-start, or if eye-start is canceled, by pressing the shutter-release button partway down; Second SPC for TTL flash metering of built-in flash or other dedicated flash unit; Metering modes: Honeycomb-pattern, center-weighted average, or spot metering (2.7% of viewfinder); Range: Honeycomb-pattern metering: EV 0 - 20; Center-weighted average metering: EV 0 - 20; Spot metering: EV 3 - 20 (ISO 100, f/1.4 lens)

Exposure Modes: Programmed AE (P mode): Automatic control of aperture and shutter speed depending on lens specifications and scene characteristics; PA, Ps: Creative Program Control

Aperture-priority AE (A mode): Any available aperture in 0.5 EV increments; Shutter speeds set from 1/8000 to 30 sec. automatically by autoexposure program

Shutter-priority AE (S mode): Any shutter speed from 1/8000 to 30 sec. selectable in 0.5 EV increments; Aperture set automatically by autoexposure program;

Manual (M mode): Any shutter speed/aperture combination selectable in 0.5 EV increments; Correct and over-/under-exposure indicated in viewfinder; BULB setting also selectable

TECHNICAL DETAILS

Built-In Flash: Guide number 12 (in meters at ISO 100); flash coverage for 24mm field of view; Recycling time: Approx. 2.5 sec. (power supplied by camera); Pre-flash for red-eye reduction and remote/wireless off-camera flash control available

TTL Flash Metering: Operates in all flash modes with built-in flash dedicated flash unit; X-sync shutter speed automatically set when flash-on indicator appears in viewfinder; In P, A, or S mode, pressing spot button sets slower shutter speed (down to 30 sec.) to balance flash with ambient lighting;

Programmed AE: Aperture and shutter speeds set automatically; Built-in and attached accessory flash fires automatically when necessary

Shutter-Priority AE: Shutter speeds from 30 sec. to 1/200 sec. selectable; Aperture set automatically; built-in and attached accessory flash will fire when activated

Aperture Priority AE: Any available aperture selectable; Shutter speed automatically set from 1/60 sec. to 1/200 sec.; Built-in and attached accessory flash will fire when activated

Manual: Any shutter speed 1/200 or slower and any available aperture usable; Built-in and attached accessory flash will fire when activated

High-Speed Sync (HSS) Flash available with 5400HS flash unit: Flash can synchronize with camera at shutter speeds 1/200 sec. to 1/8000sec.

Remote/wireless off-camera flash and ratio control are available: Flash sync in remote/wireless mode: 1/60 sec.; Flash sync in ratio control: 1/60 sec.; Control range: 5m

Film-Speed Setting: Automatic setting for DX-coded films ISO 25 - 5000; Manual setting range: ISO 6 - 6400 (1/3-stop increments); Recommended range with flash: ISO 25 - 1000

Flash Compensation: +/- 3 EV (0.5 EV increments)

Exposure Compensation: +/-3 EV (0.5 EV increments)

Exposure Bracketing: -0.5 EV, +/-0.0, +0.5 EV

Auto Programmed Zoom (only available with xi-series Autozoom lenses and specified CE cards): Programmed continuous setting of focal length based on changing subject position

Image-Size Lock (Only available with xi-series Autozoom lenses): Continuous setting of focal length to maintain image size

Shutter: Electronically-controlled, vertical-traverse, focal-plane type; Range: 1/8000 to 30 sec., bulb; Flash sync: 1/200 sec. or slower

● With shutter speeds 1/200 sec. or faster, camera will automatically switch to HSS mode (only with 5400HS flash unit)

Film transport: Automatic with built-in motor drive; Auto threading; Auto advance to first frame; Single-frame or Continuous advance; Double exposure; Automatic rewind, Manual start of rewind, or High-speed load and rewind; Frame counter in body data panel; Frame counter in viewfinder data panel with countdown of last 9 frames

Viewfinder: Eye-level fixed pentaprism; Field of view: 92% of vertical and 94% of horizontal; Magnification: 0.75 (with 50mm lens at infinity); Diopter: -1; Long eye-relief finder with protective glass; Distance from eye to eyepiece: 22.9mm; Distance from eye to eyepiece cup: 18.9mm; Panorama indicator selectable

Depth-of-Field Preview: Aperture closed down to current f-number while pressing the depth-of-field preview button; AF and AE locked

Self-Timer: Electronic with approx. 10-sec. delay; Cancelable (indication by blinking AF illuminator)

Power: 6-volt 2CR5 lithium battery; Automatic battery check when camera is turned on; Battery condition indicated by four-stage indicator in body data panel

Card System: All cards acceptable (except Customized Function Card and A/S Card)

Dimensions: 153.5 x 98.0 x 71.5mm / 6-7/16 x 3-7/8 x 2-13/16 in.

Weight: 595g/21oz. without lens and battery

Specifications and accessories are based on the latest information available at the time of printing and are subject to change without notice.

CARING FOR YOUR CAMERA

Precautions

- No part of the camera should be forced at any time.
- Polaroid instant 35mm films cannot be used.
- Never subject your camera to shock, high heat, humidity, water, or harmful chemicals. Be particularly careful not to leave it in the glove compartment or other places in motor vehicles where it may be subjected to high temperatures.
- Never lubricate any part of the camera body or lens.
- Never touch the shutter curtains, mirror, or the interior of the body or clean them with compressed air. Doing so may impair their alignment and movement.
- This camera is not waterproof, dustproof or sand-proof. If you use this camera near water or at the beach, water-, dust-, or sand-damage may occur. Protect it at all time from moisture or splashes, especially saltwater spray, and be extremely careful to keep sand from both the interior and exterior of the camera and its accessories.
- If the camera is subjected to a sudden change in temperature, as when transferring it from a cold environment into a heated building, condensation may form inside. To prevent condensation, place the camera in a sealed plastic bag before transferring it from a cold place to a warm environment, and wait for it to come to room temperature before taking it out of the bag.
- The operating range for camera's data panel is from -20 to 50°C (-4 to 122°F). At temperatures outside this range, response time and contrast will change, making the display difficult to read. At very high temperatures, a display may temporarily darken. If this occurs, the display should return when the camera is restored to operating range conditions.
- This camera contains no user-serviceable parts. Do not attempt to disassemble or repair the camera yourself.
- This camera's circuitry may switch off, even when a battery with sufficient power is installed. To resume operation, remove the battery and install it again.
- If HELP appears in the body data panel, remove the battery, then reinstall it. If it appears again after you release the shutter, take the camera to an authorized Minolta service facility.

Cleaning

- External camera surfaces and lens barrel -- but not glass surfaces -- can be cleaned by wiping with a dry or silicone-treated cloth. Never use organic solvents to clean the camera.
- Never touch the lens or eyepiece surfaces with your fingers. Whisk away loose matter with a blower brush. To remove stubborn spots, use a sheet of photographic lens tissue. If necessary, tissue may be moistened with one drop of lens-cleaning fluid; never place fluid directly on glass surfaces.
- We recommend that you have your camera cleaned once a year at an authorized MINOLTA Service Facility.
- If your camera comes in contact with water, wipe it with a clean, dry cloth and bring it to an authorized MINOLTA Service Facility. If it comes in contact with sand or if sand enters the camera, gently blow away loose particles --**wiping may scratch the camera**-- and bring it to an authorized MINOLTA Service Facility.

Storage

- Always keep your camera in its case with the lens capped when not in use, or with a body cap on when a lens is not attached.
- If you plan to store your camera for an extended period of time, rewind and remove the film, then remove the battery. Place the camera in a cool, dry place away from dust or chemicals, preferable in an airtight container with a drying agent such as silica gel. Also, it is recommended that you periodically release the camera's shutter to maintain proper working condition.
- After prolonged storage, and especially before taking pictures at an important event, carefully check the operation of the camera and lens.

Questions and Service

- If you have question about your camera, contact your local camera dealer. *For more information, write to the Minolta distributor or subsidiary in your area (addresses listed on the back of this manual).*
- To assure prompt service, please contact an authorized Minolta Service Facility before shipping your camera for repairs.

QUICK REFERENCE GUIDE

When you want to...

Cancel
Eye-Start

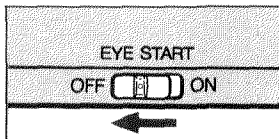

Set the
exposure
mode

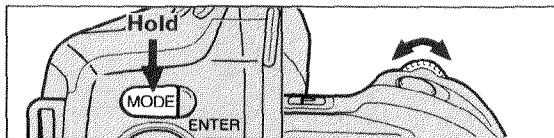

Set the
metering
mode

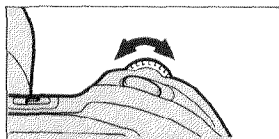
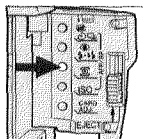

Use
self-timer

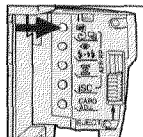

Check the
battery

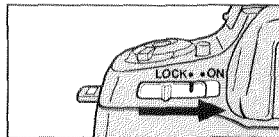

Lock spot
exposure

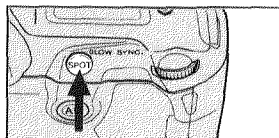

Set exposure compensation

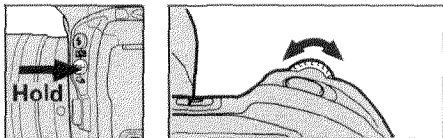

Bracket exposures

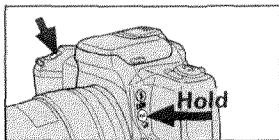

Select a local focus area

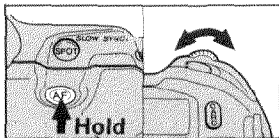

Lock focus

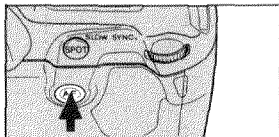

Focus manually

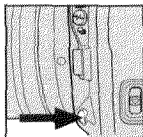

Check film speed

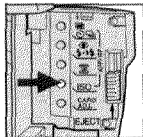

**Manually
rewind film**

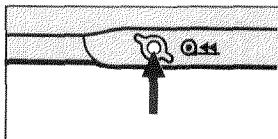

**Set high-
speed load
and rewind**

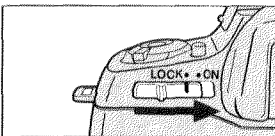
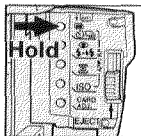

**Use manual
fill-flash
(P mode)**

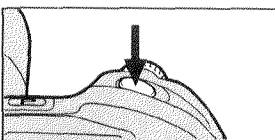
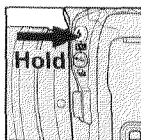

**Use slow-
shutter
sync**

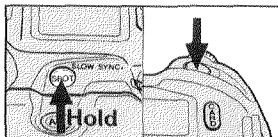

**Set flash
mode**

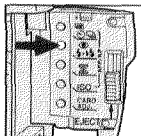

**Set flash
compensation**

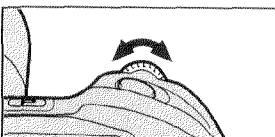
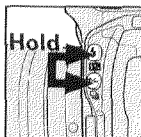

**Test-fire in remote/
wireless
flash mode**

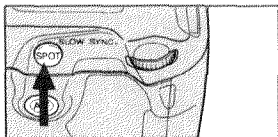

**Set drive
mode**

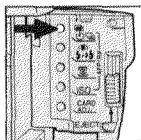

Remove lens

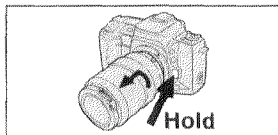

**Set release
priority**

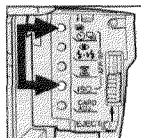

**Set
panorama
frame**

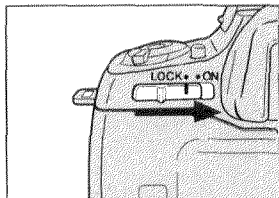
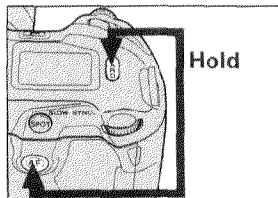



MINOLTA

Minolta Camera Co., Ltd.

3-13, 2-Chome, Azuchi-Machi, Chuo-Ku, Osaka 541, Japan

Minolta GmbH

Kurt-Fischer-Strasse 50, D 22923 Ahrensburg, Germany

Minolta France S.A.

365-367 Route de Saint-Germain, 78420 Carrières-Sur-Seine, France

Minolta (UK) Limited

1-3 Tanners Drive, Blakelands North, Milton Keynes, MK14 5BU, England

Minolta Austria Gesellschaft m.b.H.

Amalienstrasse 59-61, 1131 Wien, Austria

Minolta Camera Benelux B.V.

Zonnebaan 39, 3606 CH Maarssenbroek, P.B. 264, 3600 AG Maarssen, The Netherlands

Belgium Branch

Kontichsesteenweg 38, B 2630 Aartselaar, Belgium

Minolta (Schweiz) AG

Riedhof V, Riedstrasse 6 8953 Dietikon-Zürich, Switzerland

Minolta Svenska AB

Brännkyrkagatan 64, Box 17074, S-10462 Stockholm 17, Sweden

Finland Branch

Niitykatu 6 PL 37 SF-02201 ESPOO, Finland

Minolta Portugal Limitada

Av. do Brasil 33 a, 1700 Lisbon, Portugal

Minolta Corporation

Head Office

101 Williams Drive, Ramsey, New Jersey 07446, U.S.A.

Los Angeles Branch

11150 Hope Street Cypress, CA 90630, U.S.A.

Minolta Canada Inc.

Head Office

369 Britannia Road East, Mississauga, Ontario L4Z 2H5, Canada

Vancouver Branch

106-3850 Jacombs Road, Richmond, B.C. V6V 1Y6, Canada

Minolta Hong Kong Limited

Room 208, 2/F, Eastern Center, 1065 King's Road, Quarry Bay, Hong Kong

Minolta Singapore (Pte) Ltd.

10, Teban Gardens Crescent, Singapore 2260

© 1993 Minolta Camera Co., Ltd. under the Berne
Convention and Universal Copyright Convention